



**PRODUCTS
CATALOGUE**



AMIJAS SURGICAL
I N S T R U M E N T S



+92 333 8356790



amijasintl786@gmail.com



**P.O Box Chowni Sulehria,
Sialkot 51310 Pakistan.**



AMIJAS SURGICAL INSTRUMENTS

Amijas Surgical is leading manufacturer and exporter of Dental, Ortho and Surgical Instruments. The high quality of the company's product has been appreciated for many years through the world and Amijas Surgical will maintain this reputation by applying same degree of care and concern for manufacture and design in the past. We are willing to serve your valued and prestigious company on the basis of our top quality products on very reasonable prices within time delivery.

We have complete in-house R&D designing and manufacturing facilities. We focus on continuous improvements and new product developments to incorporate features that are superior to what is currently available in the market. Our production confirms to the highest international standards.

The wealth of hardworking knowledge and dexterity of craftsmen improving the product that have helped to create the best quality instruments which comply with all the requirements of most modern human care sector.

Our Strengths

- Sourcing of quality raw materials.
- Completely in-house production processes.
- Experienced and technically qualified workforce.
- Use of latest technologies and machineries in production.
- Compliance of strict technical and regulatory standards.
- A sense of morality, honesty, and hard work in all our dealings.

Amijas Surgical earns satisfaction of its customers. By providing quality products at fair price and on timely delivery.

Amijas Surgical certified by followings:



**ABOUT
AMIJAS**



AMIJAS SURGICAL
INSTRUMENTS

Dental Instruments



Extraction Forcep
ASI-EF-1001
Forcep for upper
root



Extraction Forcep
ASI-EF-1002
Forcep for upper
& lower root



Extraction Forcep
ASI-EF-1003
Forcep for lower
root



Extraction Forcep
ASI-EF-1004
Universal Extraction
Foreps



AMIJAS SURGICAL
INSTRUMENTS

Dental Instruments



Amalgam Carvers
ASI-AC-1005
Interproximal
Off- Angle.



Amalgam Carvers
ASI-AC-1006
Premium Quality
Stainless Steel.



Ash Forcep
ASI-AF-1008
22cm Size.



Extraction Forcep
ASI-AF-1009
Quality Stainless
Steel.



AMIJAS SURGICAL
INSTRUMENTS

Dental Instruments



Soft Brushing Kit
ASI-SB-1010
Quality Stainless
Steel.



Soft Brushing Instrument
ASI-SB-1011
Premium Quality
Stainless Steel.

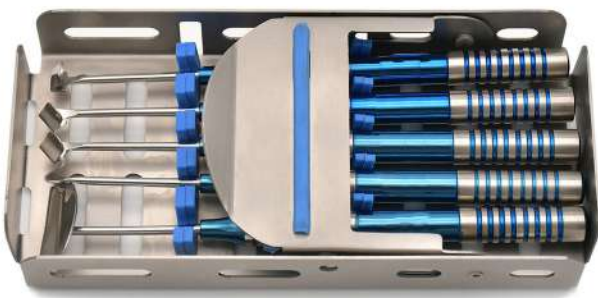

Soft Brushing Kit
ASI-SB-1012
Quality Stainless
Steel.



Soft Brushing Kit
ASI-SB-1013
Quality Stainless
Steel.



AMIJAS SURGICAL
I N S T R U M E N T S

Dental Instruments



Explorer Periodontal Probes
ASI-EB-1014
Stainless Steel
Standard Handle.



Explorer Periodontal Probes
ASI-EB-1015
Highest quality clinical
grade stainless steel

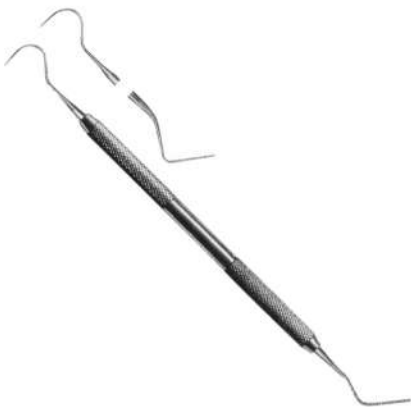

Endodontic Explorers
ASI-EB-1016
9.5 mm handle.



Endodontic Explorers
ASI-EB-1017
Quality Stainless
Steel.



AMIJAS SURGICAL
I N S T R U M E N T S

Dental Instruments

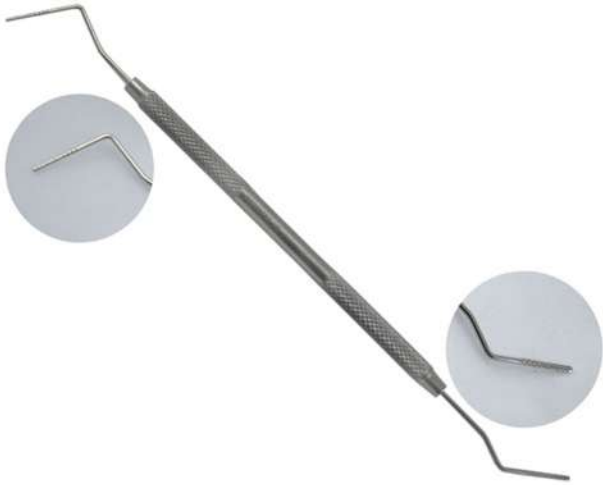

Periodontal Pocket Probes
ASI-PP-1018
Stainless Steel



Periodontal Pocket Probes
ASI-PP-1019
Stainless steel



Root Elevator
ASI-RE-1020
15 cm Long
Stainless Steel..



Root Elevator
ASI-RE-1021
15 cm Stainless
Steel.



AMIJAS SURGICAL
INSTRUMENTS

Dental Instruments



4x Distal End Ligature
ASI-DE-1022
Mathieu Needle Holder
Weingart



Dental Extracting Forceps
ASI-EF-1023
Black Titanium Coated CE



Tooth Extraction Forcep
ASI-EF-1024
Premium Quality
Stainless Steel.



Sinus Lift Elevator
ASI-RE-1025
Premium Quality
Stainless Steel.



AMIJAS SURGICAL
INSTRUMENTS

Dental Instruments



Dental Implant Instrument Kit

ASI-II-1026

**Premium Quality
Stainless Steel**



Dental Orthodontics Kit

ASI-EF-1027

**Premium Quality
Stainless Steel.**



Dental Implant Titan Surgical Tray

ASI-ST-1028

7 Blue Root Elevator



**Dental Drills Implant
Guide and Positioning Kit**

ASI-PK-1029

**Surgery pin wall expander
drill**



AMIJAS SURGICAL
INSTRUMENTS

Dental Instruments



Rubber Dam Clamp

ASI-RD-1030

Dental Instruments ENDO
With Black Tray black
plasma coated



Dental Implant Kit

ASI-DI-1031

Titanium Gold Dental Burs
Osseodensification Kit



Dental Prosthetic Kit

ASI-DS-1032

Stainless Steel



**Dental Handpiece
Cartridge Repair Tools**

ASI-RT-1033

Repairing Tool Kit



AMIJAS SURGICAL
I N S T R U M E N T S

Dental Instruments



Bookwalter Retractor Set

ASI-BW-1034

Made in high stainless steel



Dental Tunneling Procedure Kit Set

ASI-TK-1035

Sinus Lift Elevators Gum Grafting Periostomes Set



Dental Instrument Kit

ASI-DK-1036

Stainless Steel



Arthroscopy Set

ASI-RT-1037

High Quality
Stainless Steel



AMIJAS SURGICAL
I N S T R U M E N T S

Dental Instruments



Haemostatic Forceps

ASI-HF-1038
20 cm Straight
Stainless Steel



Haemostatic Forceps

ASI-HF-1039
16 cm Curved
Stainless Steel



Impression Trays

ASI-IT-1040
Stainless Steel



Tissue Pliers

ASI-TP-1041
High Quality
Stainless Steel



AMIJAS SURGICAL
I N S T R U M E N T S

Dental Instruments



Cement Spatula
ASI-CP-1042
Cement Spatula 2.5mm



Cement Spatula
ASI-CP-1043
Cement Spatula 7.0mm
Anatomical hollow
handle 6mm



Cotton Dental Tweezer
ASI-DT-1044
Dental Tweezer 16 cm
Stainless Steel



Dental Tweezer
ASI-DT-1045
15 cm
Stainless Steel



AMIJAS SURGICAL
I N S T R U M E N T S

Orthopedic Instruments



Bone Cutting Forcep
ASI-BF-3001
Angled
Stainless Steel



Bone Cutting Forcep
ASI-BF-3002
Size 240 mm



Liston Bone Cutting Forcep
ASI-BC-3003
18.4 cm
Stainless Steel



**Ruskin Liston Bone Cutting
Forcep**
ASI-BF-3004
18 cm
Stainless Steel



AMIJAS SURGICAL
I N S T R U M E N T S

Orthopedic Instruments



Track Retractor
ASI-BF-3005
Stainless Steel



Bookler Retractor Set
ASI-BF-3006
Field post 12"
Horizontal bar

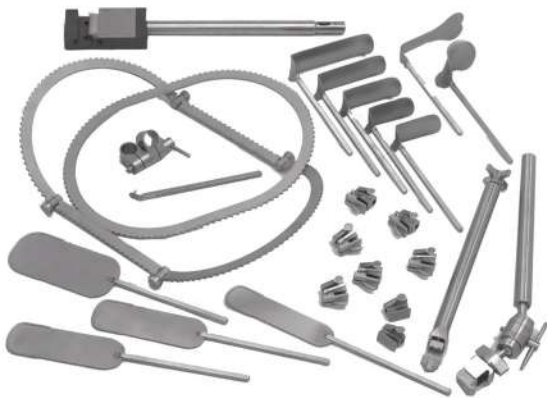

Bookwalter Retractor
ASI-BF-3007
Codman Surgical Table
Mounted



Spine Tubular Retractor
ASI-BF-3008
Minimally Invasive
Tubular



AMIJAS SURGICAL
INSTRUMENTS

Orthopedic Instruments



Rigid Laryngoscope Set
ASI-LS-3009
Stainless Steel



Retractor Fiber Optic
ASI-FO-3010
Stainless Steel

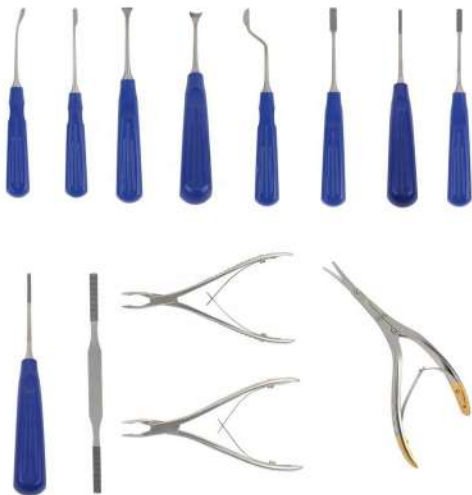

Rhinoplasty Kit
ASI-RK-3011
Rhinoplasty Preservation
Instruments Set

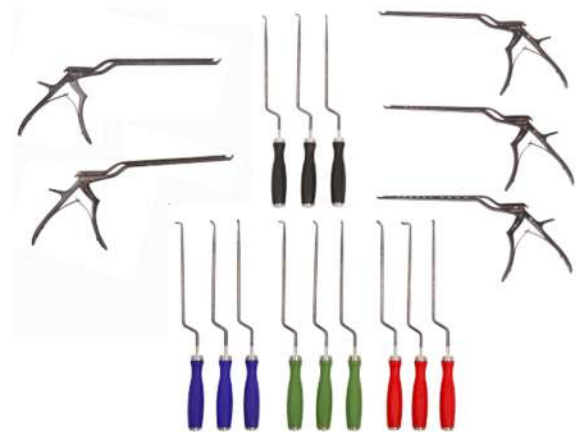

Lumbar Instrument Set
ASI-LI-3012
set for Posterior MIS Surgery



AMIJAS SURGICAL
I N S T R U M E N T S

Orthopedic Instruments

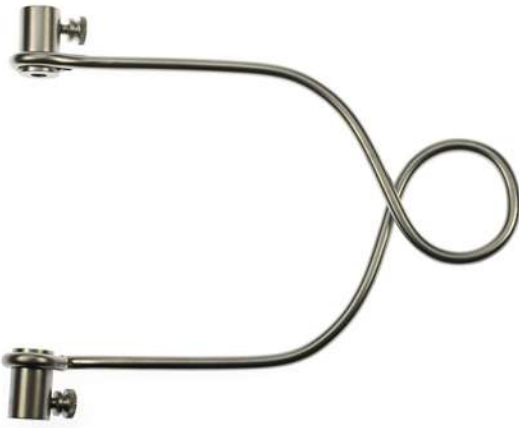

Bohler Stirrup
ASI-BS-3013
Stainless Steel



Bone Holding Forcep
ASI-BH-3014
250 mm



Bone Holding Forcep
ASI-BH-3015
Self centering
26 cm



Bone Reduction Forcep
ASI-BR-3016
160 mm



AMIJAS SURGICAL
INSTRUMENTS

Orthopedic Instruments



Orthopedic Surgery
ASI-OS-3020
Acl Pcl Set



American Rainbow Curettes
ASI-AR-3021
10" overall length.



Arthroscopy Shoulder
ASI-AS-3022
Surgical instruments set.

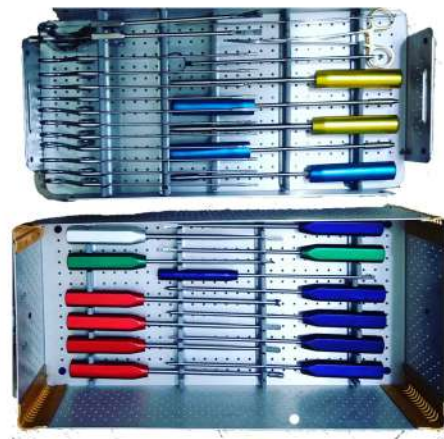

Arthroscopy Shoulder
ASI-AS-3023
Surgical instruments set.



AMIJAS SURGICAL
INSTRUMENTS

Orthopedic Instruments



Discectomy Retractor Set
ASI-DRS-3024
Casper lumbar discectomy
retractor set.

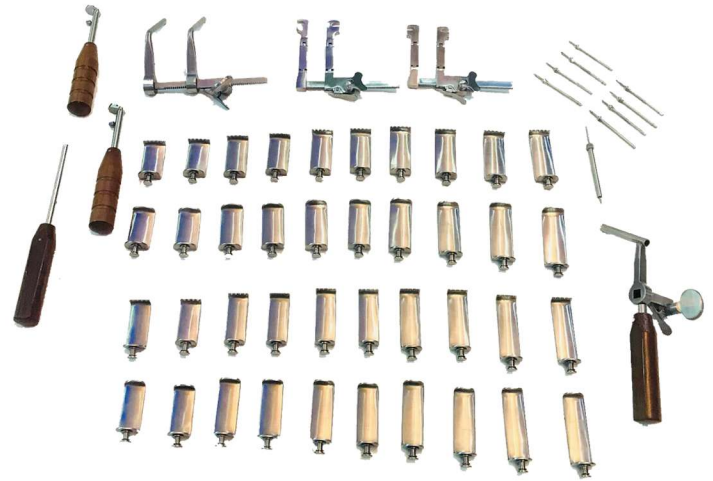

Column Retractor
ASI-CR-3025
Casper cervical vertebral
column retractor.

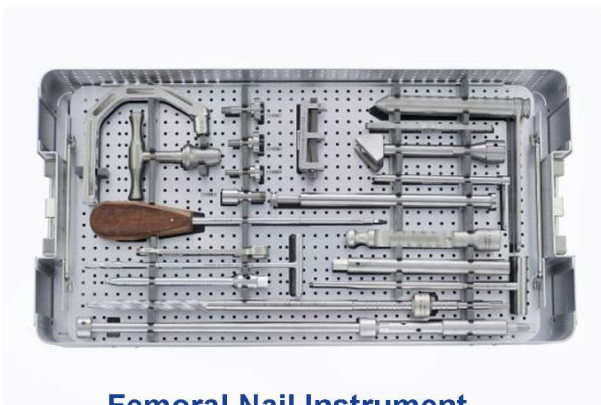

Femoral Nail Instrument
ASI-FNI-3026
Stainless Steel



Laparoscopic Retractor
ASI-LR-3027
Laparoscopic retractor nathanson
liver retractor.



AMIJAS SURGICAL
I N S T R U M E N T S

Orthopedic Instruments



Brain Retractor
ASI-BR-3028

Brain retractor neurosurgery
flexible arms surgical.



Medicon Suction Hemor
ASI-MSH-3029

Medicon suction hemorrhoid

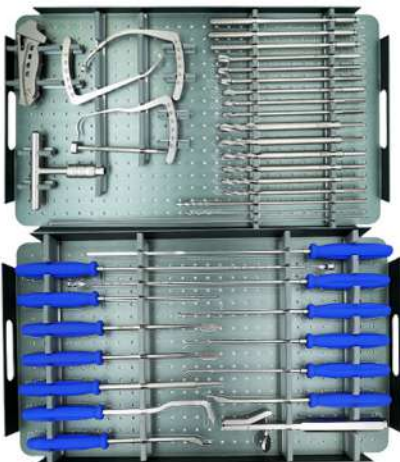

Orthpedic Set
ASI-MIS-3030
Stainless Steel

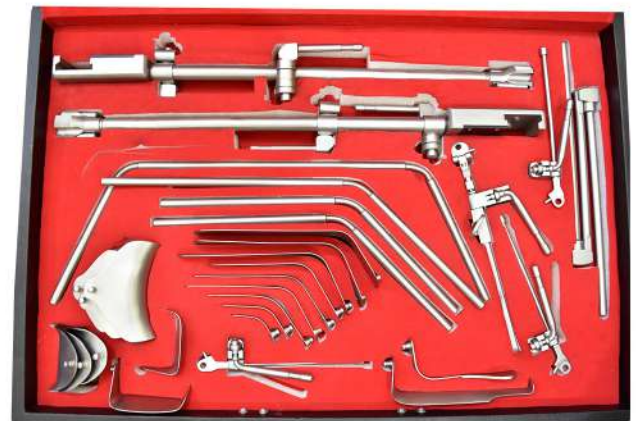

Surgical Thompson Retractor Set
ASI-RL-3031
Premium Quality
Stainless Steel



AMIJAS SURGICAL
INSTRUMENTS

Orthopedic Instruments



Orthodontics dental
ASI-OD-3032
Orthodontics dental
kit set of 19.



Orthopedic Surgical
ASI-OS-3033
Orthopedic surgical trauma
instruments pelvic.



Orthopedic Surgical
ASI-OS-3034
Orthopedic surgical trauma
instruments pelvic.



ACL Instrument Set
ASI-OS-3035
Stainless Steel



AMIJAS SURGICAL
INSTRUMENTS

Orthopedic Instruments



Periacetabular Osteotomy
ASI-PO-3036
Periacetabular Osteotomy
high quality.



Phantom Blunt
ASI-PB-3037
Phantom cs blunt
blades.



Spinal Surgery Instrument
ASI-PMM-3038
Quality Stainless Steel

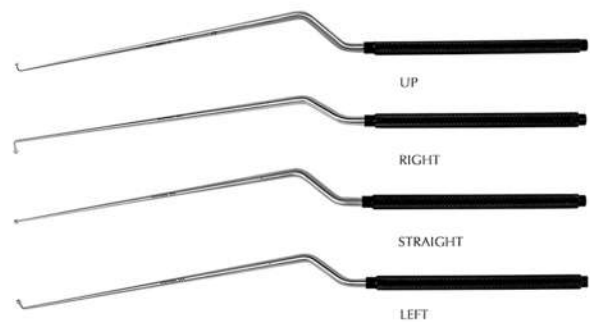

Bayonet Ball Probes
ASI-OS-3039
6" working length



AMIJAS SURGICAL
INSTRUMENTS

Orthopedic Instruments

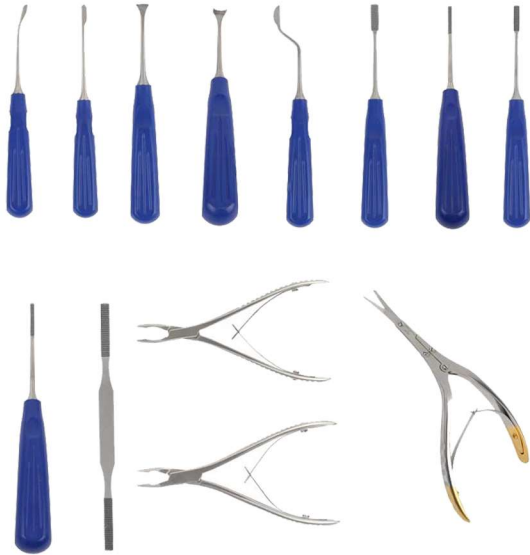

Rhinoplasty Preservation
ASI-RP-3040
Rhinoplasty preservation instruments set.



Trimline Cervical
ASI-TC-3041
Trimline cervical retractor set.



Spratt Brun Bone
ASI-SBB-3042
Spratt brun bone curette set of 6 pcs straight.

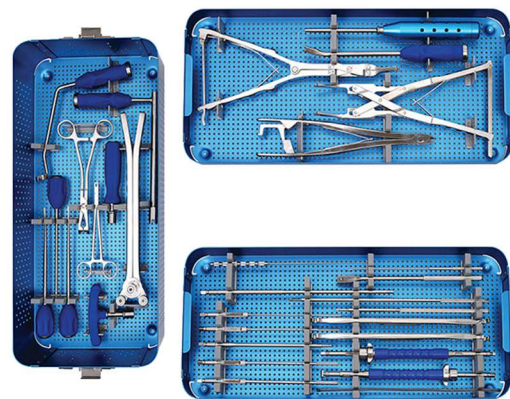

Orthopedic Surgical
ASI-OS-3043
Orthopedic surgical trauma instruments pelvic.



AMIJAS SURGICAL
I N S T R U M E N T S

Orthopedic Instruments



Pin Cutter
ASI-PC-3044
Pin cutter
Size 24cm (9.5")



Bone Cutting
ASI-BC-3045
Bone cutting forceps
size 8" inch.



Orthopedic Cutter
ASI-OC-3046
Bone cutter curved
6 Inch



Bone Cutting Forceps
ASI-BCF-3047
Size 18 cm
Stainless Less



Orthopedic Instruments



Mole Grip
ASI-MG-3048
Wire cutter, curved
jaw, 10 inch



Orthopedic Plier
ASI-PC-3049
Curved jaw and 7-inch
straight jaw.



Bone Lever
ASI-BL-3050
curved 6 mm



Bone Lever
ASI-BL-3051
8 mm



Surgical Instruments



Artery Forceps
ASI-AF-5001
Curved with tungsten
carbide inserts.



Artery Forceps
ASI-AF-5002
Stainless Steel
Curved, Serrated Jaws



Bandage Scissor
ASI-SS-5003
Size 5.5"



Bandage Scissor
ASI-SS-5004
Blunt sharp tips
Stainless steel



AMIJAS SURGICAL
I N S T R U M E N T S

Surgical Instruments



Blunt End Scissor
ASI-BS-5005
Sharp Blunt
Stainless Steel



Blunt End Scissor
ASI-BS-5006
Blunt ends hospitime



Disposable Sterile Scissor
ASI-DSS-5007
Disposable single use
Curved Shape.



Disposable Sterile Scissor
ASI-DSS-5008
Disposable single use
sterile scissor



AMIJAS SURGICAL
I N S T R U M E N T S

Surgical Instruments



Gold Mayo Stille Scissor
ASI-GMS-5009
Curved 15 cm



Gold Metzenbaum Scissor
ASI-GMS-5010
Curved 18 cm



Gold Metzenbaum scissor
ASI-GMS-5011
Straight 18 cm



Metzenbaum scissor
ASI-GMS-5012
Curved 20 cm



Surgical Instruments



Iris Eye Scissor Curved
ASI-IES-5013
Iris eye scissor curved 11cm
German stainless steel.



Iris Scissor Curved
ASI-IES-5014
14cm Curved
Super Cut.



Iris Scissor
ASI-IS-5015
Length 4" (10cm)



Iris Scissor
ASI-IS-5016
curved 11cm
stainless steel.



AMIJAS SURGICAL
I N S T R U M E N T S

Surgical Instruments



Mayo Hegar Needle Holder
ASI-MHN-5017
16 cm
Stainless Steel



Mayo Hegar Needle Holder
ASI-MHN-5018
16 cm
Straight with lock serrated



Mayo Hegar Needle Holder
ASI-MHN-5019
14 cm
Stainless Steel



TC Mayo Hegar Needle Holder
ASI-MHN-5020
14 cm
TC tip jaws



Surgical Instruments



Olsen Hegar Needle Holder Clamp
ASI-OHN-5021
Straight
6.5" (16.5 cm)



Olsen Hegar TC Needle Holder Clamp
ASI-OHN-5022
Stainless Steel
6.5" (16.5 cm)



Olsen Hegar Needle Holder Clamp
ASI-OHN-5023
5.5" (14 cm)
stainless steel.



Olsen Hegar Needle Holder Clamp
ASI-OHN-5024
14 cm
Stainless Steel



AMIJAS SURGICAL
I N S T R U M E N T S

Surgical Instruments



Operating Scissor
ASI-OS-5025
Stainless Steel



Operating Scissor
ASI-OS-5026
Operating scissor (TC)
Stainless Steel



Lister Bandage Scissor
ASI-LBS-5027
140 mm



Universal Bandage Scissor
ASI-LBS-5028
Scissors made of stainless
steel / plastic
Large 19 cm



AMIJAS SURGICAL
I N S T R U M E N T S

Surgical Instruments



Strabismus Scissor Curved
ASI-SSC-5029
stainless steel



Strabismus Scissor
ASI-SSS-5030
Strabismus scissor straight



Strabismus Scissor
ASI-SSS-5031
supercut scissors
with black handle



Strabismus Scissor Curved
ASI-SSC-5032
Serrated tungsten carbide
blunt tip.



AMIJAS SURGICAL
I N S T R U M E N T S

Surgical Instruments



Surgical Scissors
ASI-SSG-5033
Black Coated



TC Suture Wire Scissor
ASI-SWS-5034
High quality stainless.



Suture Wire Scissor
ASI-SWS-5035
High quality stainless.



Tonsil Scissor
ASI-TS-5036
High quality stainless.



AMIJAS SURGICAL
I N S T R U M E N T S

Surgical Instruments



Bone Chisels
ASI-BC-5037
5 mm bladed tip



Bone Chisels
ASI-BC-5038
5 mm bladed tip



Bone Files
ASI-BF-5039
Stainless Steel



Bone Files
ASI-BF-5040
Stainless Steel
Weight 1LBS



AMIJAS SURGICAL
I N S T R U M E N T S

Surgical Instruments



Periotomes
ASI-PS-5041

Highly polished finish
for aesthetic and corrosion
resistance



Periotomes
ASI-PS-5042

Highly polished finish
for aesthetic and corrosion
resistance



Aspiration
ASI-AS-5043

Poole straight suction



Aspiration
ASI-AS-5044

Poole straight suction
tube 9.25"



AMIJAS SURGICAL
I N S T R U M E N T S

Surgical Instruments



Chrocodial Forcep
ASI-CF-5045
Single use chrocodial
forcep.



Chrocodial Forcep
ASI-CF-5046
Stainless Steel



Chrocodial Forcep
ASI-CF-5047
Stainless Steel



Laparoscopic Trainer
ASI-LT-5048
Laparoscopic trainer training practice
kit grasper dissector scissors instruments.



AMIJAS SURGICAL
I N S T R U M E N T S

 +92 333 8356790

 amijasintl786@gmail.com

 P.O Box Chowni Sulehria,
Sialkot 51310 Pakistan.